

EBERSPÄCHER UK | TECHNICAL MANUAL

# AIRTRONIC D2 / D4 / D4+ OPERATING INSTRUCTIONS AND SERVICE BOOK



**HAGER**  
Groothandel & Techniek



**Uncontrolled Copy**

This publication was correct at the time of going to print.

However, Eberspächer (UK) Ltd. have a policy of continuous improvement and reserve the right to amend any specifications without prior notice.

# Contents

---

Technical Data .....	4
Operating Instructions for 801 Series Digital Modulator .....	5
Operating Instructions for Rheostat Control Switch .....	6
Operating Instructions for Modulator Control (301 Series) .....	7
Adjusting Temperature Using Rheostat or Modulator Control .....	8
Operating Instructions for 7 Day Timer with Temperature Controller .....	9 - 10
Operating Instructions for 701 Series Timer / Modulator .....	11 - 12
Airtronic Modulator Instructions 301 00 200 .....	13
Mini Controller Operating / Mounting Instructions .....	14
Operating Instructions for 801 Series Digital Modulator .....	15 - 16
Method of Operation Airtronic D2 / D4 .....	17 - 18
Sectional Drawing Airtronic D2 / D4 .....	19
Controls and Safety Devices .....	20
Circuit Diagram Airtronic D2 / D4 - Short Optional Loom .....	21
Wiring Diagram for Control Switches .....	22
Circuit Diagram Airtronic D2 / D4 - Long Optional Loom .....	23
Wiring Diagram for Control Switches .....	24
Fuel at Low Temperatures .....	25
Operation with Bio-diesel .....	26
Fault Diagnosis Using 7 day Timer .....	27 - 28
Recommended Service Schedule Airtronic D2 / D4 .....	29
Safety Instructions .....	30
Important Information .....	31

## Technical Data

Heater type		Airtronic					
Heater		Airtronic D2 / Airtronic D4 / Airtronic D4 Plus					
Version		D2 / D4 / D4 Plus					
Heating medium		Air					
Control of the heat flow		Stage					
		Power	Large	Medium	Small	Off	
Heat flow (watt)	D2	2200	1800	1200	850	–	
	D4	4000	3000	2000	900	–	
	D4 Plus	4000	3000	2000	900	–	
Heater air flow rate without counter-pressure (kg/h)	D2 with hood Ø 60 mm	105	90	60	40	13	
	D4 with hood Ø 90 mm	185	150	110	60	24	
	D4 Plus with hood Ø 75 mm	175	140	100	55	22	
Fuel consumption (l/h)	D2	0.28	0.23	0.15	0.10	–	
	D4	0.51	0.38	0.25	0.11	–	
	D4 Plus	0.51	0.38	0.25	0.11	–	
Elektr. power consumption (watt) in operation (12 and 24 volt)	D2	34	22	12	8	5	
	D4	40	24	13	7	5	
	D4 Plus	55	30	16	7	5	
at start (12 and 24 volt)		≤100					
Rated voltage		12 or 24 volt					
Operating range Lower voltage limit: An undervoltage protection in the controller switches off the heater when the voltage limit is reached.		approx. 10.5 volt resp. 21 volt Undervoltage protection trigger time: 20 seconds					
Upper voltage limit: An overvoltage protection in the controller switches off the heater when the voltage limit is reached.		approx. 16 volt resp. 32 volt Overvoltage protection trigger time: 20 seconds					
Fuel "Fuel quality" and "Fuel at low temperatures" see page 25.		Commercially available diesel fuel (DIN EN 590)					
Tolerable ambient temperature		Operation		Not running			
		Heater	–40 °C to +70 °C		–40 °C to +85 °C		
		Dosing pump	–40 °C to +50 °C		–40 °C to +125 °C		
Maximum air intake temperature		+40 °C					
Interference suppression		Interference suppression class 5 to DIN EN 55 025					
Weight		D2 approx. 2.7 kg – D4 / D4 Plus approx. 4.5 kg					
Ventilation mode		possible					



**Caution!**

**Safety instructions for technical data!**

Failure to comply with the technical data can result in malfunctions.

**Please note!**

Provided no limit values are given, the technical data listed is subject to the tolerances usually applicable to heaters of ±10% for nominal voltage, ambient temperature 20 °C and reference altitude Esslingen.

## Operating Instructions for 801 Control Switch

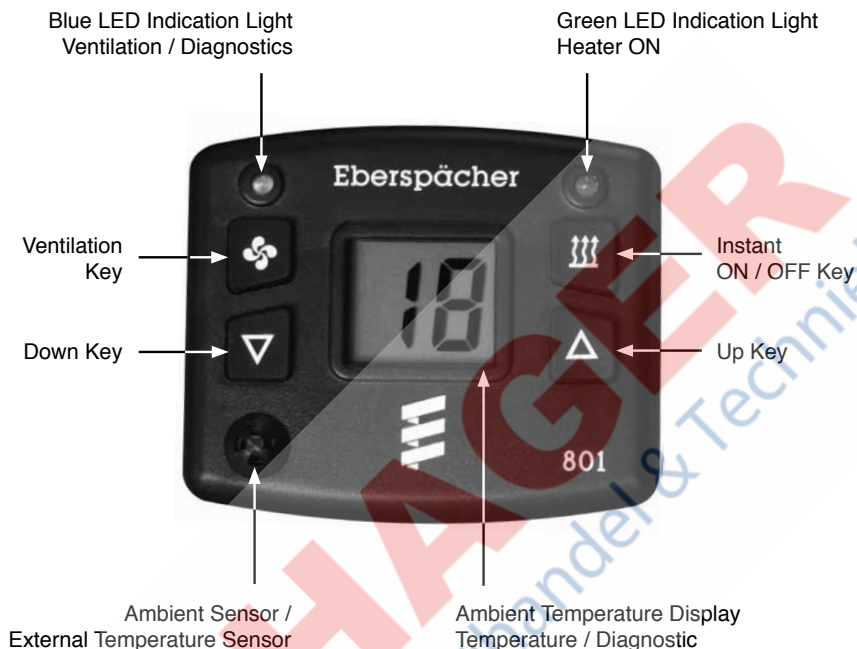

### To Start Heating

Press "Instant On / Off" key to activate heater, the "Green LED Indication Light" will illuminate and the blower motor will start and hot air will be delivered in approximately 120 seconds from switch on. To select the temperature press the "Up" or "Down" key and hold until the desire temperature is displayed.

**Please Note:** The ambient temperature is displayed by default, the set point temperature is briefly displayed when either the "Up" or "Down" key is pressed.

### To Stop Heating

Press the "Instant On / Off" key.

The "Green LED Indication Light" will go out. The blower motor will continue to run for approximately 240 seconds and automatically switch off.

Please refer to page 15 for the complete 801 instructions guide.

## Operating Instructions for Rheostat Control Switch

---

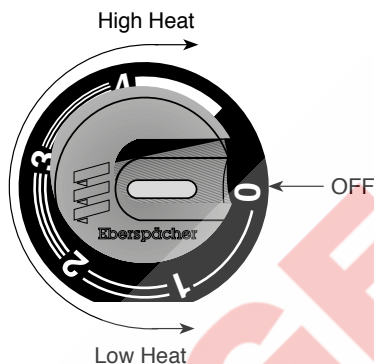

### To Start Heating

Turn rotary knob clockwise to RED field. The dial is numbered from 0-4. Number 1 is low heat and number 4 is high heat setting. The green pilot light in the centre of the switch will illuminate, blower motor will start and hot air will be delivered in approximately 120 seconds from switch on.

### To Stop Heating

Turn rotary knob anti-clockwise to 0 position.

The green pilot light in the centre of the switch will go out. Blower motor will continue to run for approximately 240 seconds and automatically switch off.

## Operating Instructions for Modulator Control (301 Series)

---

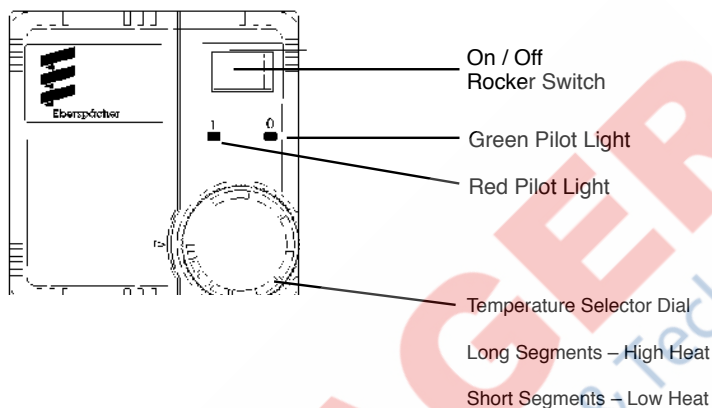

### To Start Heating

Press rocker switch to the left position for "ON".

The red pilot light (power on) and green pilot light will illuminate. Turn rotary knob clockwise to align with long segments on dial (high heat setting). Blower motor will start and hot air will be delivered in approximately 120 seconds from switch on.

### To Stop Heating

Press rocker switch to the right position for "OFF".

The red and green pilot lights will go out.

Blower motor will continue to run for approximately 240 seconds and automatically switch off.

## Adjusting Temperature Using Rheostat or Modulator Control

---

Select desired comfort heat level by turning the rheostat (see page 6) between number 1 & 4 or modulator knob (see page 7) to align between long segments for high heat and short segments for low heat level. To adjust temperature control for Timer Modulator Alarm see operating instructions shown for appropriate controller. You may have to experiment to achieve the desired heat comfort level as each vehicle will have different rates of heat loss through the roof, windows etc.

A temperature sensor is fitted inside the heater, which, in conjunction with the operating temperature control unit, controls the heat output between Power, High, Medium, Low or off depending on the air temperature and/or control settings.

If the temperature of the air in the cab is less than approximately + 10°C the heater will automatically maintain maximum heat output. Above 10°C the heater will automatically regulate across all heat levels.

The heater will maintain a temperature of within approximately 4°C of the desired heat comfort level by regulating between Power, High, Medium or Low heat output.

Should the temperature rise above the desired heat comfort level by 2°C or more, it will then switch itself off. However, the blower fan will still continue to run at an extremely low fan speed (constant ventilation mode) until the air temperature drops down by approximately 4°C. The heater will then restart to maintain once again the desired heat comfort level.





# Operating Instructions for 7 Day Timer with Temperature Controller and Fault Diagnostic Display

(Part Number: 22 1000 30 40 00)

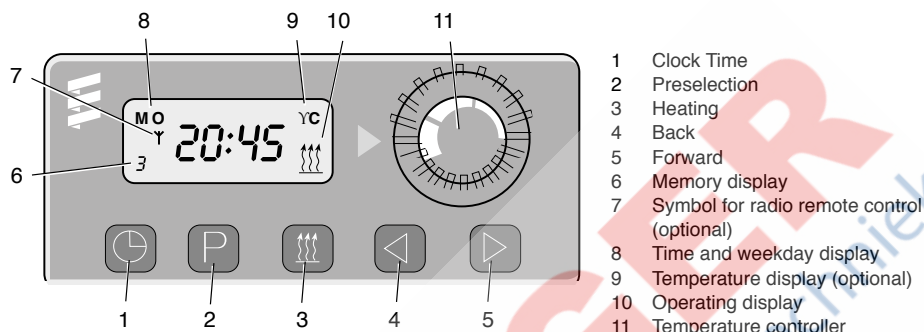

After connection of the power supply the display will show all the signals flashing – the timer must now be set.

The heater cannot be switched on in this condition.

## Setting up timer

Press  key briefly: 12:00 flashes on the display. Set the clock time with  or . The time is stored after a short delay or the key is pressed. Then the weekday flashes.

Set the current day with  or . The day is stored after a short delay or the  key is pressed again.

To adjust the current time or change day, follow the same procedure.

## Heating Operation

To switch on heater press . The heater remains in continuous operation.

To switch off heater press . automatic delay in shut off for cooling down.

## Pre-Selected Heating Start up Time

Press  several times until the required memory number (1, 2 or 3) appears flashing on the display.

Press  or  key briefly and release, then set pre-selected time using  or  keys.

As soon as the flashing stops then the weekday starts flashing. Set the weekday using the  or  keys. The pre-selected time and weekday are stored as soon as the time display reverts back to the current time. The memory number indicates what memory is activated. Only one memory can be activated at a time.

## Changing Pre-Selected Heating Duration

The heater operates for 120 minutes from pre-selected start up time: This is factory set. Should you wish to change the duration, press the  key and hold it down for approx. 3 seconds until display changes to heating duration.

Adjust using the  or  keys until desired duration is selected.

After a short delay the display returns to current time and the duration is set.

## Clearing Preselect Memory

Press  several times until no memory numbers are displayed.

## Displaying Preselect Memory

Press . The activated pre-selected time and pre-selected day are displayed for approximately 5 seconds.

## Operation - Temperature Controller

The desired room temperature can be set using the temperature controller (integrated into the controller clock). The heating device adjusts itself automatically within the preset temperature range.

## Temperature Range

Left limit stop: Lowest temperature approx. 10°C.

Right limit stop: Highest temperature approx. 30°C.

## Please Note

Voltage drops and brief disconnection from the battery do not effect the timer, but if the display is flashing then a reset is necessary.

Radio remote control operation is possible with the appropriate accessory.

If a fault occurs when the heater is switched on then the operating display flashes  $\llcorner$  and the fault code number is displayed. (Workshop Repair).

## In the Event of Malfunction, We Recommend

Switch off and back on again (not more than twice);

Check the main fuse;

Check air ducts for blockage;

Call in at an authorised service centre.

**The heater must not be operated in a garage.**

**Always switch off the heater when filling the fuel tank.**

## 701 Series Timer / Modulator with Diagnostic Readout Instructions

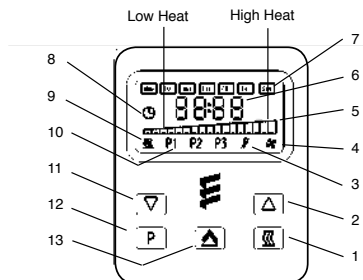

1. Instant Heat ON/OFF key
2. Adjustment Up key
3. Disengaged pre-set symbol
4. Ventilation symbol
5. Temperature ramp.
6. Current Time, Preset Time, Heating Time, Run Time and Diagnostics.
7. Day selected indicator boxes.
8. Clock symbol.
9. Heater operation symbol.
10. Preset Programme symbols.
11. Adjustment Down key.
12. Programme key.
13. Set/Programme key.

### Introduction

Your Timer/Modulator offers manual and programmable control along with temperature adjustment of your heater. When the heater is switched on by the Timer/Modulator in a programmed mode it will run for 1 hour or for the duration time that you have selected e.g Heater on at 0700, duration time of 1 hour, which means heater will be switched off automatically at 0800.

### Clock Settings

Press and hold key until the symbol begins to flash. Use the and keys to set correct time. Press and release the key and the day box will begin to flash. Use the and keys to set the correct day. Press and release the key again to reset the clock to the start of the minute displayed. This may be used to coincide with a known time signal.

**Please Note:** These adjustments are not possible when the heater is in operation. To set the heater's programmable switch on timer, see "Setting Program Times".

### Switching on the Heater (Manually)

Press the key and the symbol will appear on the display. The heater will commence its startup cycle. The display will change to show a default of one hour heating countdown time. This can be extended in increments of 10 minutes, 30 minutes, 1 hour, 1 hour 30 minutes, 2 hours up to eight hours or to

continuous running operation (shown as C-- on display) by repeatedly pressing the key while the heater is in operation. Current time will be displayed every 5 seconds.

### Switching off the Heater (Manually)

The heater may be switched off at any time by pressing the key. The cooling down cycle will then be initiated.

### Adjusting the Temperature

Pressing the and keys will alter the 20 segment temperature ramp shown on the display. This level may be adjusted at any time and will remain in the timer memory when the heater is not in operation.

### Diagnostic Readout

With the heater switched on, press and hold key until the display shows "dAtA". Release key and display then shows "AF--" and alternatively displays the current fault code. Each press of the key will scroll through the last 5 previously stored fault codes.

### Typical Fault Codes

- 10 = Over voltage - Check battery charging system.
- 11 = Under voltage - Check battery voltage.
- 12 = Overheating - Check air ducts for obstruction.
- 52 = Safety time exceeded - Check fuel supply.

For other codes consult your local dealer.

Press **■** and **■** keys together to erase stored faults and display shows "EEEE".

To exit diagnostic mode, press and release the **■** key. If stored faults cannot be erased consult your local dealer.

## Heater Run Time

Press and hold the **■** key until the display shows the heater run time in hours.

## Setting Programme Times

Press the **■** key and the P1 symbol will begin to flash. Pressing the **■** key will alternate the display between a preset time display and "OFF". With P1 flashing in the time display mode the desired programme time can be set using the **■** and **■** keys.

Once the desired time has been selected and if no keys are depressed for 8 seconds the display will revert to the clock mode. During this 8 second period pressing the **■** key will select P2 which can be used to select another programme time or be set to "OFF" if not required.

A further pressing of the **■** key will select the P3 symbol which can be set or turned off in the same manner as above.

## Setting Programme Days

Having set programme times P1, P2 or P3 or all three, press the **■** key, all the **■** symbols that have been selected will start flashing and a box will appear around one of the days.

Press the **■** key to select "ON" if you require the selected day to be programmed, or "OFF" if you do not wish it to be selected.

To move onto the following day press the **■** key once again and select "ON" or "OFF" as before. Repeat this procedure for all seven days. To store these settings in the Timer / Modulator memory, wait for 8 seconds and the display will revert to the clock mode.

## Setting Programme Duration

To set the desired heater duration, press and hold the **■** key and whilst holding repeatedly press the **■** key to select the desired time in increments of 10 minutes, 30 minutes, 1 hour, 1 hour 30 minutes, 2 hours up until 8 hours.

**Note:** Continuous operation is not selectable in this programme mode.

Once stored the preset duration time cannot be adjusted during heater "ON" operation.

## Switching on the Heater (Programmed)

To activate your selected program settings, press the **■** key to show the P1,P2,P3 (to determine when the heater will switch on) or symbol **■** to turn off all settings.

**Note:** If all presets and days have been selected to "OFF" pressing the **■** key will have no effect.

When the heater has been switched on manually, it is possible to view which of the programmed times have been set and whether or not they have been activated. Press the **■** key to view and if any programmed time has been activated, its corresponding P will flash. If no programmed times have been activated then **■** flashes. Press the **■** key to activate or de-activate the programmed times as required. Wait 8 seconds and the display will revert to manual operation countdown.

## Ventilation

To activate Ventilation Mode, repeatedly press **■** key until only one segment shows in the ramp. Press and hold the **■** key until **■** shows and display changes to 1 hour countdown. To stop ventilation, press **■** key to return to normal display time.

**Please Note:** The ventilation countdown time of 1 hour is not adjustable.

## Airtronic Modulator Instructions 301 00 200

---



Heating "ON" RED L.E.D

Ventilation "ON" BLUE L.E.D

Rotary temperature turn dial

The switched modulator with heat, vent and built in external temperature sensor is suitable for the Airtronic range of heaters only. This unit is dual voltage. Connect to 12v or 24v D.C

### Ventilation Operation

When the fan (symbol) is selected on the rocker switch (right push) the Airtronic heater will turn on the heater fan blower. No heated air will be produced from the heater unit. A blue L.E.D illuminates.

### Heating Operation

When the heat (symbol) is selected on the rocker switch (left push) the Airtronic heater will turn on as detailed in the technical description manual. A red L.E.D illuminates. Select the temperature required by adjusting the rotary turn dial. Temperature range is adjustable between 10°C and 30°C.





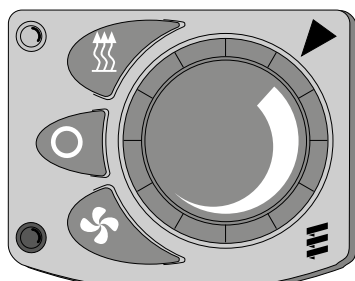

Long segments – Highest temperature

Short segments – Lowest temperature

## Mini Controller Operating / Mounting Instructions

---



-  Temperature preselection control knob
  - Left-hand end stop approx. 8°C - small amount of heat
  - Right-hand end stop approx. 34°C - large amount of heat
-  Heater
-  Red LED - Operation check for heater
-  Switch off (not in combination with mini clock)
-  Ventilator
-  Blue LED - operation check for ventilator



### Order No. 22 1000 32 07 00

The mini controller enables you to set the heater installed in the vehicle to the temperature you require.



You can either use the mini controller alone or in combination with the mini-clock.

### Stand-Alone Mini-Controller

#### Start Heater - Heating Mode

Use the  button to start the heater in heating mode (continuous operation). You can adjust the required temperature with the control knob . If the heater is in heating mode, the red LED lights up as a check.

#### Start Heater - Ventilation Mode

Use the  button to start the heater in ventilation mode (continuous operation). The control knob  has no function in ventilation mode. If the heater is in ventilation mode, the blue LED lights up as a check.

#### Switch off Heater

Use the  button to switch off the heater. Heater or ventilation mode is terminated and the corresponding LED goes out.

Heating mode is terminated with after run.

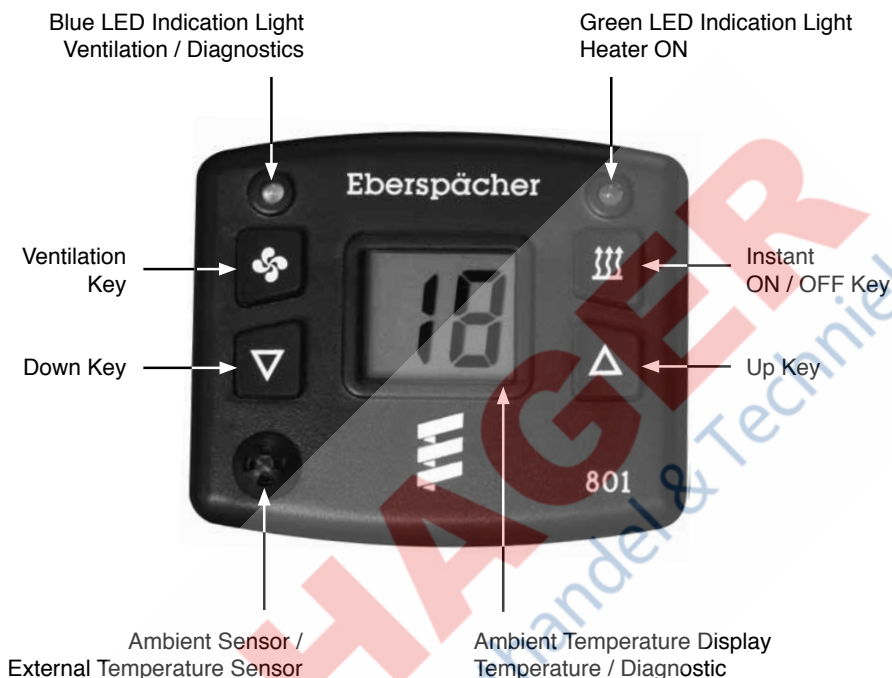

## Operating Instructions for 801 Series Digital Modulator





### Introduction

The 801 Modulator offers manual control and digital temperature adjustment of your Airtronic heater.

### Switching on the Heater (Manually)

Press the  key and  will briefly appear on the display. The heater will commence its start up cycle.

Also, the green LED  Heater ON  indication light will illuminate and the display will now revert to show ambient temperature (°C).

**Note:** The 801 10 001 version will only run for a maximum period of 1 hour.



The ambient display temperature range is from -9°C to +59°C.

## Switching off the Heater (Manually)

The heater may be switched off at any time by pressing the  key.

The heater cooling down cycle of 3 minutes will then be initiated. Wait for blower fan to stop before isolating batteries (if isolator is fitted).



## Adjusting the Temperature

Pressing the  or  keys will alter the desired temperature shown on the display. This level may be adjusted at any time and will remain in the modulator memory when the heater is not in operation.

When the  or  keys are released the display will revert back to show ambient temperature.

The Modulator temperature adjustment range is from 5°C to 32°C.





## Diagnostic Readout

With the heater switched on, press and hold  key until the display shows . The blue LED will briefly illuminate. Release the key. After a short time the LED flickers momentarily during diagnostic data transfer then goes off. The display shows FO followed by its fault code then automatically scrolls through any previously stored fault codes, up to a maximum of 5.

## Typical Fault Codes

10	=	Over voltage - Check battery charging system.
11	=	Under voltage - Check battery voltage.
12	=	Overheating - Check air ducts for obstruction.
52	=	Safety time exceeded - Check fuel supply.

For other fault codes consult your local Eberspächer dealer.

Press  and  keys together to erase stored fault codes and display shows . To exit diagnostic mode, press and release the  key.

If stored fault codes cannot be erased consult your local Eberspächer dealer.

## Ventilation

To activate Ventilation Mode, press and hold the  key until the blue LED illuminates and display shows active rotating two digits.

**Note: The 801 10 001 version will only run for a maximum period of 1 hour.**

To stop ventilation, press  key briefly. Blue LED switches off and display shows ambient temperature.



# Method of Operation Airtronic D2 / D4 / D4+

---

## Function

### Switching On

The pilot lamp in the operating control lights up when the heater is switched on.

The glow pin is switched on and the fan will start running at a low speed.

#### **Please Note:**

If there is any residual heat within the heat exchanger from a previous heating operation, the fan only (cold blowing) will run until the residual heat has been dissipated.

### Start

#### **Airtronic D2**

Fuel starts to be delivered after approx. 60 seconds.

The fuel-air mixture in the combustion chamber ignites. Once the combi-sensor (flame sensor) has detected the flame, the glow pin is switched off after 60 seconds.

After another 120 seconds the Airtronic has reached the control stage POWER (maximum fuel quantity and maximum fan speed).

#### **Airtronic D4 / D4+**

Fuel starts to be delivered after approx. 60 seconds.

The fuel-air mixture in the combustion chamber ignites. Once the combi-sensor (flame sensor) has detected the flame, the glow pin is switched off after 80 seconds.

The Airtronic is in the control mode.

### Temperature Selection with the Operating Controls

The desired temperature is pre-selected with the operating controls. Depending on the temperature selected, on the size of the room to be heated, and on the prevailing outdoor temperature. This value may range between +10 °C and +30 °C. The control switch setting to be selected is an experimental value.

### Control in Heating Mode

In heating mode the room temperature and the temperature of the heating air is continuously measured.

Control commences if the temperature exceeds the temperature pre-selected on the control element.

4 control levels have been provided so that the heat flow supplied by the heater can be accurately adapted to the heating requirements. Each control setting has its own fan speed and fuel quantity. If the adjusted temperature is ever exceeded at the lowest control level then the Airtronic is adjusted to the **OFF** control level and the fan will continue to run for approx. 240 seconds to allow the heater to cool down.

Afterwards the fan will continue to run at the slowest speed (re-circulation mode) or will be switched off (fresh air mode) until a renewed start of the heater.

## Fan Only Mode Ventilation (Optional)

To start the Airtronic in fan mode, the change-over switch  Heating/ventilating  needs to be actuated first before the heater is switched on.

### Switching Off

As soon as the Airtronic is switched off the pilot lamps go out and fuel pump is switched off. The fan will continue to run for approx. 240 seconds to cool down the heater.

For cleaning, the glow pin is switched ON for 40 seconds while the fan is still running.

### Heating Operation at High Altitudes

#### Up to 1500 m

Unrestricted heating operation is possible.

#### Above 1500 m

Heating operation is in principle possible for short periods when crossing a mountain pass or during a brief stop at high altitude.

In case of extended stays (e.g. winter camping) the fuel supply has to be adapted to the high altitude conditions. Please consult the responsible regional sales agency.

## Sectional Drawing Airtronic D2 / D4 / D4+

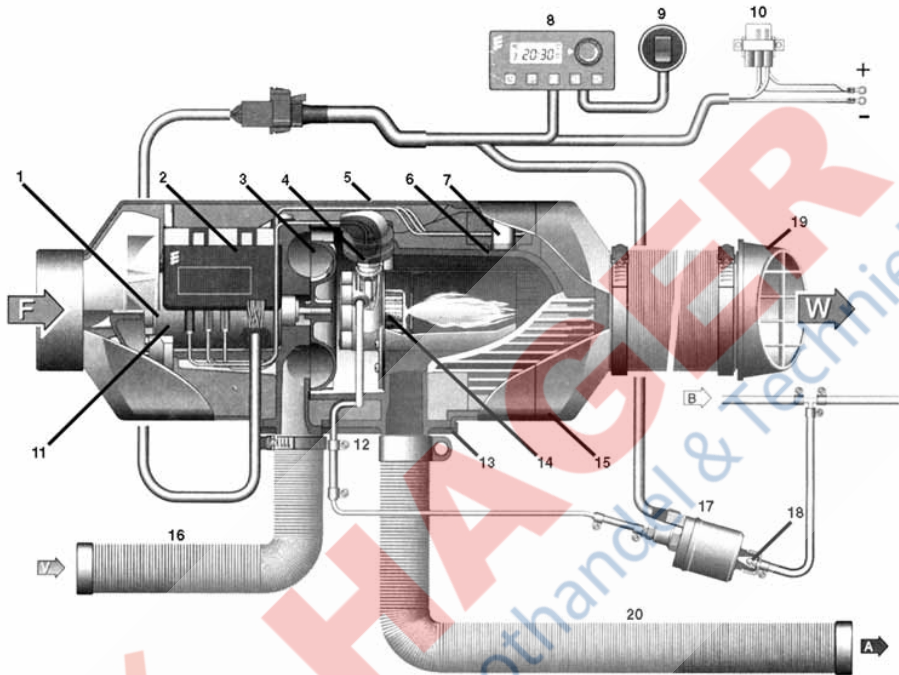

- |    |   |    |                                  |
|----|---|----|----------------------------------|
| 1  | Intake-air impeller.                                  | 14 | Combustion chamber.              |
| 2  | Control unit.   | 15 | Outlet hood                      |
| 3  | Combustion air impeller.                              |    | D2 = Ø 60/75 mm                  |
| 4  | Glow pin.   |    | D4 = Ø 75/90 mm.                 |
| 5  | Cover.  | 16 | Combustion air hose.             |
| 6  | Heat exchanger.                                       | 17 | Fuel metering pump.              |
| 7  | Combi flame sensor /<br>overheating sensor.           | 18 | Filter built into the fuel pump. |
| 8  | Module clock.   | 19 | Hot air outlet.                  |
| 9  | Change-over switch heating /<br>ventilation optional. | 20 | Flexible exhaust tube.           |
| 10 | Fuse carrier with main fuse and<br>switch fuse.       | F  | = fresh air.                     |
| 11 | Electric motor.                                       | W  | = hot air.                       |
| 12 | Fuel connection.                                      | A  | = exhaust gas.                   |
| 13 | Flange seal.  | B  | = fuel.                          |
|    |   | V  | = combustion air.                |

## Controls and Safety Devices

---

If the Airtronic does not ignite within 90 seconds after the fuel pump has started, then the start is repeated in the manner described. A malfunction cut-off is effected if after a further 90 seconds of fuel pumping the Airtronic once again fails to ignite, i.e. fuel pump switches off and the blower motor continues to run for approx. 240 seconds.

If the flame extinguishes by itself during operation, a renewed start is carried out first. If the Airtronic fails to ignite within 90 seconds after fuel pumping has started again or if it does ignite but then extinguishes itself within the next 15 minutes, a malfunction cut-off is effected, i.e. fuel pump switches off and the blower motor continues to run for approx. 240 seconds.

It is possible to override a malfunction cut-off by briefly switching the heater off and on again. **Do not repeat this more than twice in succession.**

In the case of over-heating, the combi-sensor will respond, the fuel supply will be interrupted and a malfunction cut-off will be effected.

Once the cause of overheating has been eliminated, the Airtronic can be restarted by briefly switching it off and on again.

If the upper or lower voltage limit is reached, a malfunction cut-off is effected after 20 seconds.

The Airtronic will not start if the glow pin or blower motor is defective or if the electrical line to the fuel pump is interrupted.

In the case of defective temperature-sensor or interruption in the electric wire, the Airtronic does not start and the malfunction shutdown then takes place.

The speed of the fan motor is continuously monitored. If the fan motor does not start or if the speed deviates by more than 10%, a malfunction cut-off is effected after 30 seconds.

When switching off the Airtronic, the glow pin is switched on for 40 seconds while the fan motor is running to clean it of any combustion residues.

### In the Event of Malfunction, Check the Following Points

If the Airtronic does not start when it is switched on:

Switch off the Airtronic and then switch it back on again, but no more than twice in succession.

If the Airtronic still does not start, then check:

Is there fuel in the tank?

Have any fuses blown?

Airtronic 12 V - main fuse 20 A;

Airtronic 24 V - main fuse 10 A;

Airtronic 12/24 V - control fuse 5 A.

Are all electric wires and connections ok?

Are the heating-air duct, combustion air hose or the exhaust-gas tube blocked?

If the Airtronic unintentionally remains in ventilating mode after it is switched on, the control element has to be checked for a short circuit.

If these points are OK, then proceed with a diagnosis test using the JE diagnosis unit or either the 701 or 801 controller, which incorporates fault code display.

# Circuit Diagram - Airtronic D2 / D4

## Heaters supplied with short optional loom

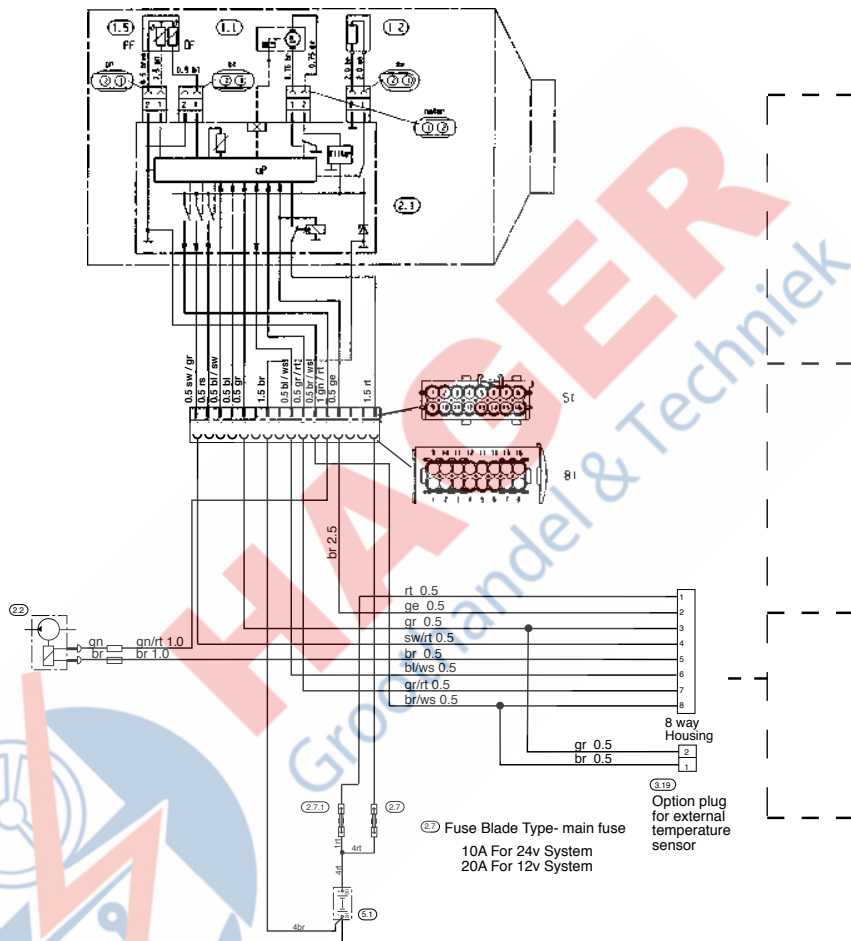

### Parts List

- |        |   |        |  |
|--------|---|--------|--|
| 1.1    | Blower Motor.                           | 3.1.7  | Mini controller (22 1000 32 07 00).                  |
| 1.2    | Glow Pin.                               | 3.1.8  | Modulator with vent (301 00 200).                    |
| 1.5    | Combi flame sensor/overheating sensor.  | 3.1.11 | Rheostat switch (Optional).                          |
| 2.1    | Electronic Control Unit (ECU).          | 3.1.12 | Modulator switch (Optional - 301 series).            |
| 2.2    | Fuel Metering Pump.                     | 3.2.8  | DIN timer 7 day with temperature control (Optional). |
| 2.7    | Main fuse 20A- 12v, 10A- 24v.           | 3.2.9  | Timer / Modulator 7 day, (701 10 003 series).        |
| 2.7.1  | Switch Fuse 5A.                         | 3.2.10 | Digital Modulator 801 Series.                        |
| 2.15.1 | External Temperature Sensor (Optional). | 5.1    | Battery.   |

# Wiring Diagram for Control Switches

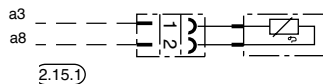
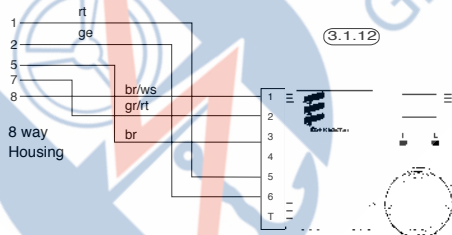
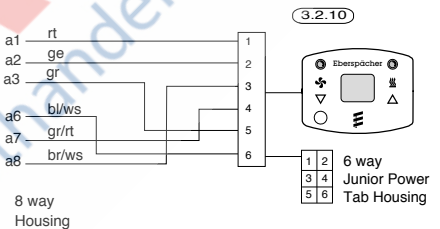
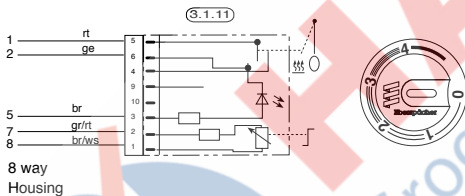
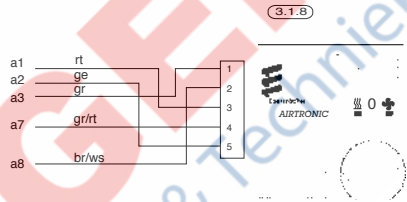
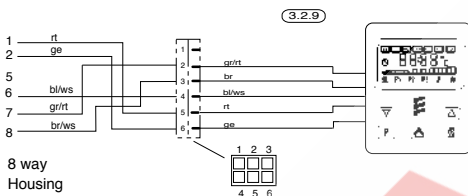
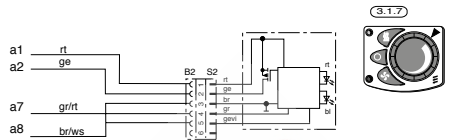
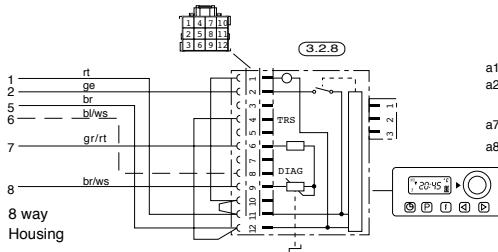

## Wiring Colour Codes

- rt - red
- br - brown
- ws - white
- sw - black
- gn - green
- ge - yellow
- gr - grey
- bl - blue

- a1 Supply to positive terminal 30.
- a2 Switch on signal S+.
- a3 External temperature sensor (Optional).
- a4 Fresh air blower integrated in vehicle blower control (Optional).
- a5 Supply to negative terminal 31.
- a6 Fault diagnostic signal.
- a7 Nominal temperature rheostat signal.
- a8 Sensor reference signal.

# Circuit Diagram - Airtronic D2 / D4 / D4+ Heaters Supplied with Long Optional Loom

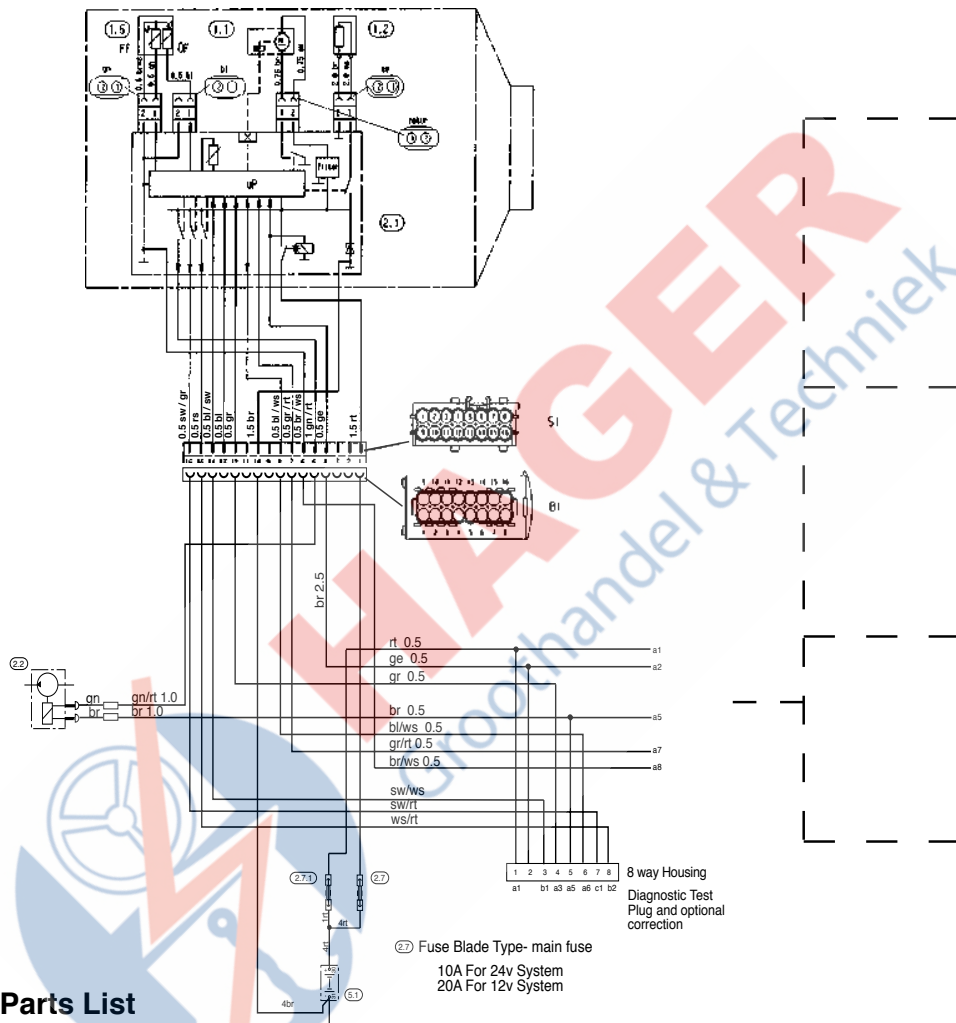

# Wiring Diagram for Control Switches

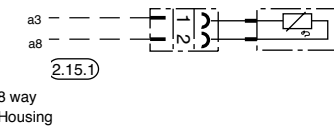
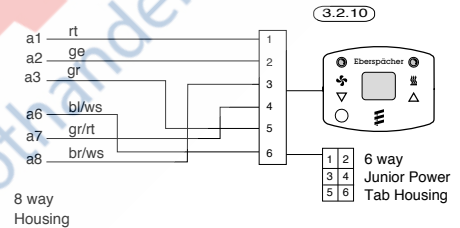
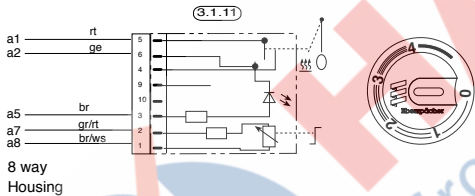
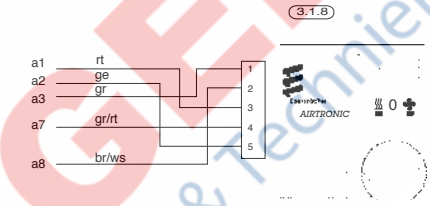
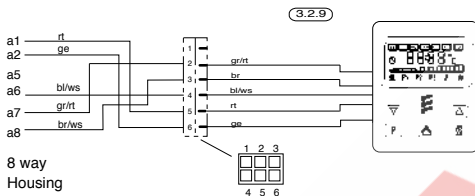
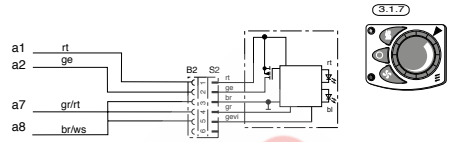
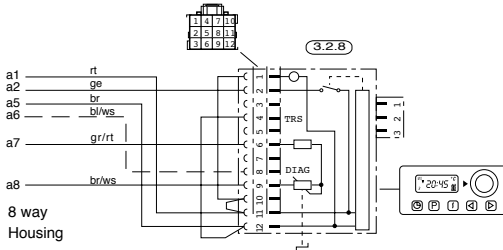

## Wiring Colour Codes

- |            |             |
|------------|-------------|
| rt - red   | gn - green  |
| br - brown | ge - yellow |
| ws - white | gr - grey   |
| sw - black | bl - blue   |

- |    |   |    |  |
|----|---|----|--|
| a1 | Supply to positive terminal 30.         | a8 | Sensor reference signal.   |
| a2 | Switch on signal S+.                    | b1 | Ignition + positive for TRS (ADR/Pet Reg) heaters only (Optional). |
| a3 | External temperature sensor (Optional). | b2 | Timer disconnect for TRS ADR/Pet Reg heater only.                  |
| a5 | Supply to negative terminal 31.         | c1 | Optional fresh air blower integrated in vehicle blower control.    |
| a6 | Fault diagnostic signal.                |    |  |
| a7 | Nominal temperature rheostat signal.    |    |  |



## Fuel at Low Temperatures Supply from Separate Fuel Tank Only

---

The heater works on commercially available diesel fuel (to DIN EN590 specification). Adoption of the fuel to normal winter temperatures is automatically allowed for by the oil refineries (winter diesel). Difficulty could only arise in the event of an extreme drop in temperature (as it would also for the engine - see the vehicle instruction manual).

To avoid such a possibility, if the heater is supplied from a separate fuel tank, the following rules should be followed. At temperature above freezing (0°C or 32°F), any type of diesel fuel or light fuel oil may be used. At temperatures below freezing, fuel oils will require the appropriate additives.

If no special cold weather diesel fuel is available for low temperatures, mix kerosene, paraffin or gasoline according to the adjacent table. A separate tank is available from the Eberspächer dealer.

### For use with Separate Fuel Tank Only

Temperature	Winter Diesel Oil	Additive
From 0°C to -15°C**	100%	—
From -15°C to -25°C	50%	50% kerosene or petrol
From -25°C to -40°C	—	100% kerosene*

\* or special winter diesel oils.

\*\* or in accordance with fuel manufacturer's specifications.

The fuel line and the fuel pump must be filled with new fuel by operation for 15 minutes.

### Fuel Supply



Danger of fire and explosion!  
Poisonous fumes!

Caution when handling fuel before filling up, and when working on the fuel supply switch off the vehicles engine and the Airtronic heater.

## Operation with Bio-Diesel (FAME)

---

### Airtronic

The heater is **not** approved for operation with bio-diesel fuel (FAME). Up to 10% bio-diesel fuel (FAME) may be added.

### Airtronic M

The diesel heater is approved for operation with bio-diesel fuel (FAME) according to DIN EN 14 214.

**Please Note:**

Bio-diesel fuel (FAME) according to DIN EN 14 214:

- During the winter months is adapted to low temperatures from 0 °C to -20 °C.
- The Flowability reduces at temperatures below 0 °C.

When using 100% bio-diesel, the heater should be operated twice a year with diesel fuel (in the middle and at the end of a heating period) in order to burn off any possible bio-diesel residues deposited. To do so, let the vehicle tank run almost empty and then fill with diesel fuel. While running on this tank filling, switch the heater on 2 to 3 times for 30 minutes at a time at the highest temperature setting.

When operating with diesel / bio-diesel mixtures of up to 50% bio-diesel, intermediate operation with pure diesel fuel is not necessary.

## Fault Diagnosis Using the 7 Day Timer with Temperature Control (Optional)

Timer Module Display (GB) Part. No. 22 1000 30 40 00

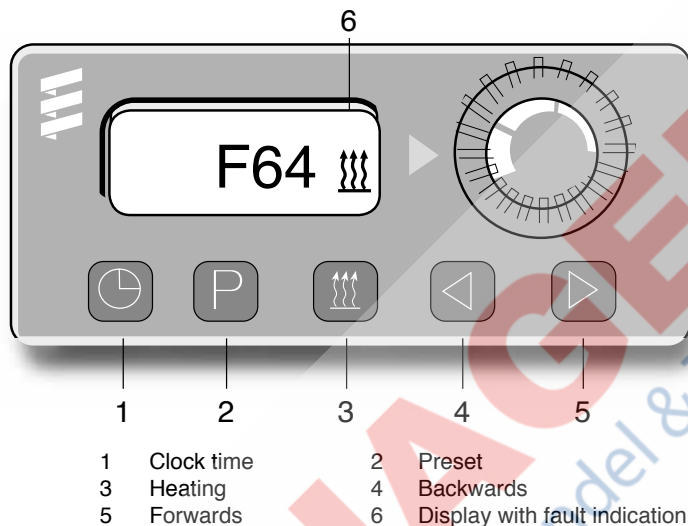

If the control unit detects a fault when the heater is switched on or while the heater is in operation, the timer module indicates this by means of an F and as a 2-figure number within 15 seconds.

Reading on display, e.g. **F64** (Current fault) and flashing heating symbol.

### How to Enquire for Fault Memory in the Heater Control Unit Using the Timer Module

The electronic control unit can store up to 5 faults which can be read out and displayed on the timer module. The current fault is written to memory location F1.

Preceding faults are written to memory locations F2 – F5.

### Fault Memory Enquiry

Press the **■** key - the heater is switched on - then press the **■** key, hold it down and press the **■** key within 2 seconds. The current error is now displayed by AF, i.e. AF 64.

The stored errors (i.e. F 64) can be called up using the **■** and **■** keys.

## Lock Out of the Heater Control Unit can be Caused by Overheat



The hardware limit for the overheat has been exceeded. Code 17 is shown. If switched on again code 15 is displayed. The control unit is locked out.

### Canceling the Control Unit Lock Out, and/or Erasing the Fault Memory

**Note:** This can only be operated providing that the electrical connection from ignition to the timer module (12-pin connector) terminal 10 is connected.

#### To Cancel Control Unit Lock Out



Turn on the ignition.

Press  key - the current fault is displayed (i.e. F15 / F50)  
- then press the  key, hold it down and press the  key within 2 seconds.

The timer module is now in the “Enquire fault memory” program.

#### Now Proceed as Follows

Turn off the ignition.

Press keys  and  simultaneously, switch on the ignition and wait until the following reading appears on the display.

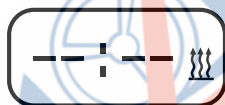

Reading on display after switching ignition “ON”.  
Display flashing, heating symbol not flashing.

The control unit lock out is cancelled after 3 seconds, then the heater will start up. Providing there are no further faults with the heater.



Reading on display after heater has started.  
Display: No current fault.  
Heating now operational.

**Note:** For diagnostic wiring connections (i.e.: blue/white wire) see pages 21 and 23.

## Recommended Service Schedule Airtronic D2 / D4 / D4+

	Every Month	Every 6 Months	Every Year (each September)
1. Remove glow pin and inspect for carbon build up. Clean and/or replace.			●
2. Replace fuel screen in glow pin port with special tool supplied with new screen.			●
3. Check for blocked or damaged ducting and rectify or replace as required.		●	●
4. Inspect intake and outlet grilles for blockages; also inspect intake fan blades for any restriction.	●	●	●
5. Check electrical connections, including main fuse holders, for corrosion.		●	●
6. Check for blocked or damaged exhaust tube.		●	●
7. Check for blocked or damaged combustion air tube.		●	●
8. Test fire heater and check for correct operation	●	●	●
9. Check exhaust colour as a guide for carbon build up.		●	●
10. Check heater delayed shut down time, (approximately 240 seconds after switching off).		●	●
11. Check all fuel lines and connections for security and abutments; also ensure there are no fuel leaks.		●	●
12. Remove fuel metering pump filter and replace.			●
13. Remove all dirt and corrosion from fuel metering pump.		●	●
14. Check fuel metering pump for correct delivery of fuel as shown in the Airtronic <b>D2/D4 Troubleshooting and Repair Manual</b> . (Service station only).			●
<p><b>Important:</b> Please note the heat exchanger must be replaced after 10 years of service.</p> <p><b>Note:</b> It is advisable that the 6 month/annual service is carried out by an approved Eberspächer Agent.</p>			



## Safety Instructions Concerning the Installation and Repair of the Airtronic



### Danger of Burns and Injury!

***Before commencing any work on the Airtronic, disconnect the vehicle battery.***

The Airtronic may only be started up if the top cover and the hood have been mounted in accordance with the regulations and if the air duct on the suction and heating air side has also been carried out in accordance with the regulations.

During operation the top cover must not be opened and hot parts must not be touched.

### Important Instructions for the Installation and Repair of the Airtronic

When installing, servicing, and mounting or repairing the heater, only original spare parts must be used.

Changes to the Airtronic or to components relevant to the heating are not approved by Eberspächer. This includes air and exhaust systems.

Only the control elements provided and / or approved by Eberspächer, either on their own or in a given combination, may be used to operate the Airtronic. The use of other control elements may lead to malfunctions of the heater / heating.

### Operation

Non-compliance with the statutory, safety and / or function specifications may lead to the lapse of the General Design Certification (ABG) of the Airtronic and also to the exclusion of guarantee and liability on the part of the company J. Eberspächer GmbH & Co.

## Important Information

---

### Caution

- Switch off heater before refuelling.
- Do not cover heater in such a way as to block inlet or outlet air ducts.
- Never operate the heater in confined spaces (i.e. garages).
- Every combustion process generates exhaust gas, which has toxic constituents, because of this and high temperatures generated, the exhaust pipe **must** comply with the installation instruction.
- Failure to comply with the instruction or operation of the heater in confined spaces (i.e. garages) harbours the risk of poisoning.
- The heater may only be used for the purpose specified by the manufacturer and in compliance with the operating instructions supplied with every heater.
- Operating the heater is not permitted when inflammable vapours or dust can build up, e.g. near fuel, coal or sawdust stores, grain silos, granaries etc.
- Switch off heater and wait for blower fan to stop before isolating batteries.
- When the heater or the heating system is damaged, an authorised workshop must be called in to repair the damage using genuine spare parts.
- When carrying out electric welding work on the vehicle, disconnect the positive terminal from the battery and earth it in order to protect the control unit.
- Do not place aerosol cans, gas canisters, alcohol, inflammable liquids or inflammable materials in front of the heater or hot air outlets.
- Prior to entering flood or standing water, please switch off heater and wait 240 seconds for heater to stop.

# HAGER

Groothandel & Techniek



**Eberspächer (UK) Ltd**

Headlands Business Park  
Salisbury Road, Ringwood  
Hampshire BH24 3PB

Tel: +44 (0)1425 480151

Fax: +44 (0)1425 480152

[enquiries@eberspacher.com](mailto:enquiries@eberspacher.com)

[www.eberspacher.com](http://www.eberspacher.com)



Eberspächer